

Pearl

Pearl Swivel Joint

— Swivel Joint —

A/AS/B/C/CS Series

CATALOG

PEARL  JOINT

株式会社 昭和技研工業

SHOWA GIKEN INDUSTRIAL CO., LTD.

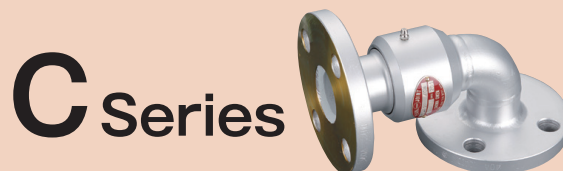

Features

Steel balls are arranged in two rows in the bearing section and lubricated with grease, allowing for 360° smooth rotation.

A ring packing such as an O-ring is used as a main seal, providing stable seal performance.

Six styles are available depending on the combinations of bodies and shafts.





You can select the main seal material and grease according to the fluid used and application.

Table of Contents

Features	P1
Service Conditions	P2
Styles	P2
Structures and Materials	P3
Dimensions	P4
A Series	P4
AS Series	P4
B Series	P5
C Series	P6
CS Series	P6
Masses	P7
Dynamic Torque	P8
Model Names and Types	P9
Precautions on Selection	P10
Maintenance	P11
Product Order	P11
Product Warranty	P12

The contents are subject to change without notice.

Service Conditions

Series	Connection	Material (main parts)	Main Seal	Style	Size	Max.	
						Pressure (MPa)	Temperature (°C)
A 	Taper Thread (Rc)	Ductile Cast Iron Carbon Steel	O-ring NBR	1~6	10A~100A	4.1	100
					10A~40A	4.1	100
AS 	Taper Thread (Rc)	Stainless Steel	O-ring NBR	1~3	50A	4.1	
					65A, 80A	2.1	
					10A~15A	13.7	
B 	Taper Thread (Rc)	Carbon Steel	O-ring NBR	1~3	20A~32A	9.0	100
					40A	6.0	
					10A~15A	13.7	
C 	Flange	Carbon Steel	O-ring NBR	1~6	40A~300A	2.1	100
CS 	Flange	Stainless Steel	O-ring NBR	1~6	40A~200A	2.1	100

Note 1) The main seal for the standard specification of each series is an O-ring (NBR).

2) The maximum service temperature of 100°C is applicable when using the standard main seal (NBR).

3) 20A to 40A of B series can be used for up to 13.7 MPa under the following conditions.

- ① When the swivel operation is not performed while fluid is flowing at a pressure of the maximum value in the table above to 13.7 MPa.
 - ② When the swivel operation is performed while fluid is flowing at a pressure of the maximum value in the table above to 13.7 MPa, but the frequency of swivel operation is below our standard value.
- Contact our sales representative for more information.

Styles

Depending on shapes, six styles are available for each series.

Style 1

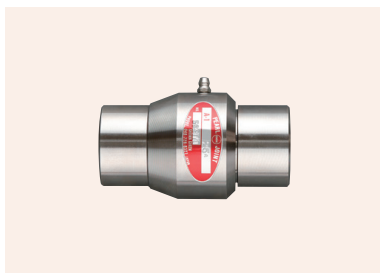

Style 2



Style 3



Style 4



Style 5



Style 6



Structures and Materials

A AS

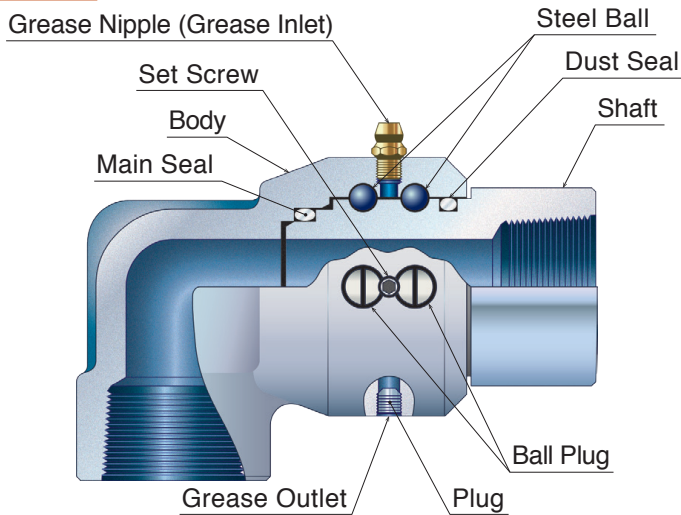

Materials of Main Components (Standard Specification)

A	Part Name	Material
	Shaft	Ductile Cast Iron
	Body	Carbon Steel
	Main Seal	NBR

Shafts and bodies of sizes 10A - 50A are finished with electroless nickel plating. Heat-resistant paint is applied to external parts of sizes 65A - 100A.

Materials of Main Components (Standard Specification)

AS	Part Name	Material
	Shaft	Stainless Steel
	Body	
	Main Seal	NBR

B

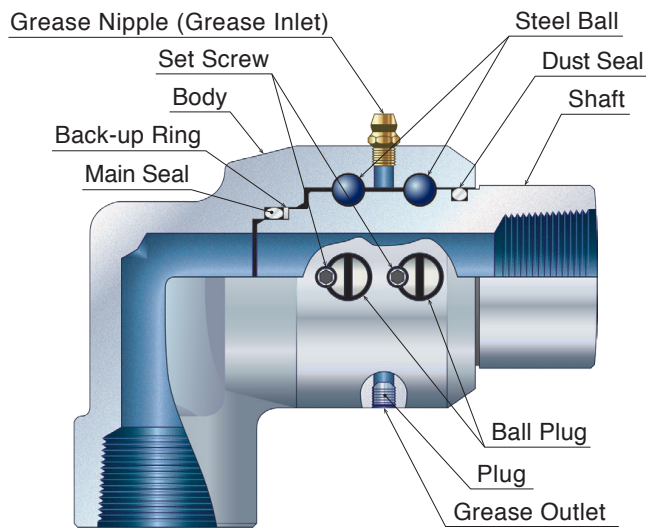

Materials of Main Components (Standard Specification)

B	Part Name	Material
	Shaft	Carbon Steel
	Body	
	Main Seal	NBR

The shaft and body are finished with electroless nickel plating.

C CS

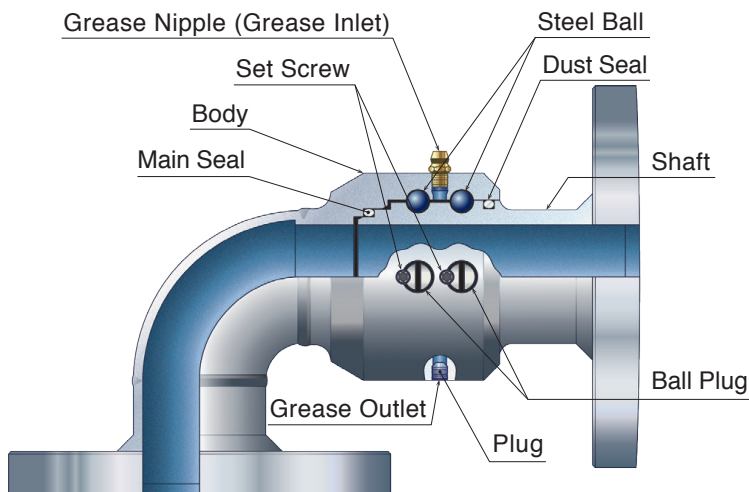

Materials of Main Components (Standard Specification)

C	Part Name	Material
	Shaft	Carbon Steel
	Body	
	Main Seal	NBR

Heat-resistant paint is applied to external parts.

Materials of Main Components (Standard Specification)

CS	Part Name	Material
	Shaft	Stainless Steel
	Body	
	Main Seal	NBR

Note) Component materials are indicated on product drawings.

Contact our sales representative for requests for product drawings.

Dimensions (A Series / AS Series)

Style 1

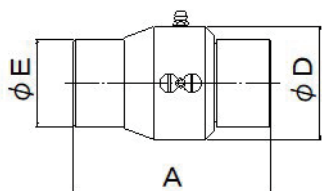

Style 2

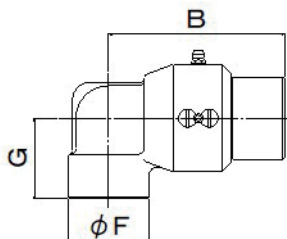

Style 3

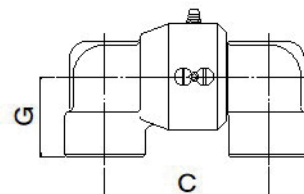

Style 4

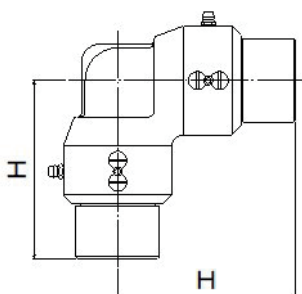

Style 5

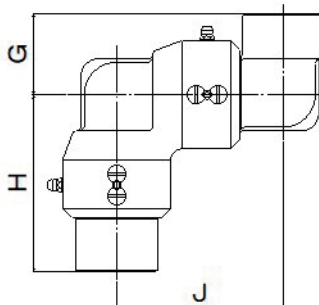

Style 6

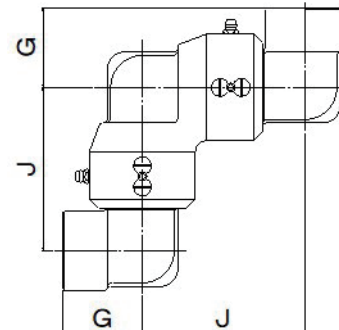

A Series, Dimension Table

(mm)

Size	Connection	A	B	C	D	E	F	G	H	J
10A	Rc3/8	84	74	70	44	32	32	35	74	70
15A	Rc1/2	84	74	70	44	32	32	35	74	70
20A	Rc3/4	105	98	92	60	46	45	45	98	92
25A	Rc1	105	98	92	60	46	45	45	98	92
32A	Rc1¼	120	110	109	77	63	63	70	110	109
40A	Rc1½	120	110	109	77	63	63	70	110	109
50A	Rc2	150	145	155	98	78	78	75	145	155
65A	Rc2½	181	176	190	132	105	105	100	176	190
80A	Rc3	181	176	190	132	105	105	100	176	190
100A	Rc4	210	210	232	160	135	134	120	210	232

AS Series, Dimension Table

(mm)

Size	Connection	A	B	C	D	E	F	G	H	J
10A	Rc3/8	84	74	70	44	32	32	35	95	91
15A	Rc1/2	84	74	70	44	32	32	35	95	91
20A	Rc3/4	105	98	92	60	44	43	45	125	119
25A	Rc1	105	98	92	60	44	43	45	125	119
32A	Rc1¼	120	110	109	76	56	62	70	125	124
40A	Rc1½	120	110	109	76	62	62	70	130	129
50A	Rc2	150	145	155	94	75	78	88	-	-
65A	Rc2½	180	200	230	113	94	91	69	-	-
80A	Rc3	191	220	250	125	109	105	78	-	-

Dimensions (B Series)

Style 1

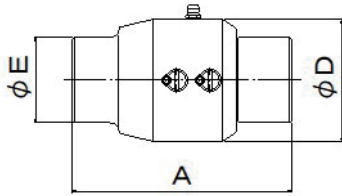

Style 2

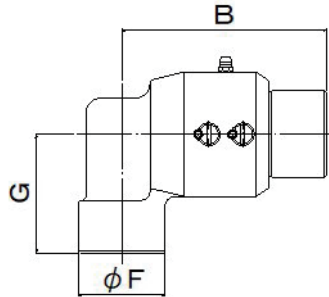

Style 3

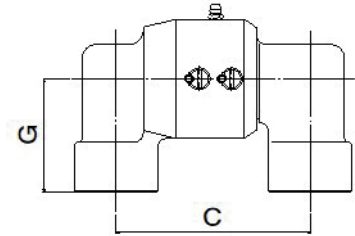

B Series, Dimension Table

(mm)

Size	Connection	A	B	C	D	E	F	G
10A	Rc3/8	91	77	73	48	32	32	49
15A	Rc1/2	91	77	73	48	32	32	49
20A	Rc3/4	118	108	107.5	66	46	46	63
25A	Rc1	118	108	107.5	66	46	46	63
32A	Rc1¼	120	130	135	72	58	58	45
40A	Rc1½	120	134	145	78	64	64	51

Dimensions (C Series / CS Series)

Style 1

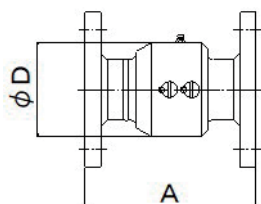

Style 2

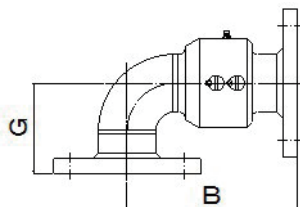

Style 3

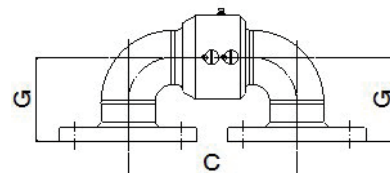

Style 4

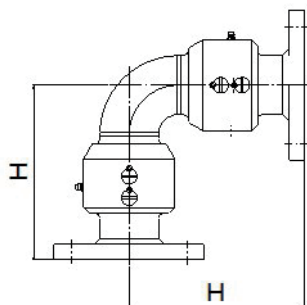

Style 5

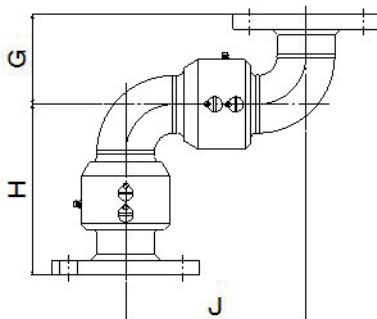

Style 6

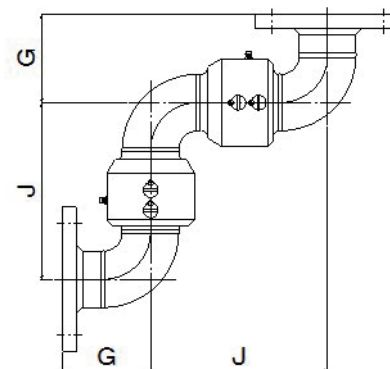

C Series, Dimension Table

(mm)

Size	A	B	C	D	G	H	J
40A	160	160	160	76	80	160	160
50A	170	180	190	94	95	180	190
65A	190	205	220	113	115	205	220
80A	205	230	255	125	135	230	255
100A	220	265	310	152	160	265	310
125A	250	315	380	185	190	315	380
150A	280	365	450	225	225	365	450
200A	320	450	580	278	280	450	580
250A	350	525	700	330	340	525	700
300A	400	620	840	380	395	620	840

CS Series, Dimension Table

(mm)

サイズ	A	B	C	D	G	H	J
40A	160	160	160	76	80	160	160
50A	170	180	190	94	95	180	190
65A	190	205	220	113	115	205	220
80A	205	230	255	125	135	230	255
100A	220	265	310	152	160	265	310
125A	250	315	380	185	190	315	380
150A	280	365	450	225	225	365	450
200A	320	450	580	278	280	450	580

Masses

■ Masses of A Series (kg)

Size	Style					
	1	2	3	4	5	6
10A	0.6	0.65	0.75	1.0	1.1	1.2
15A	0.55	0.6	0.7	0.9	1.0	1.1
20A	1.3	1.4	1.6	2.2	2.3	2.5
25A	1.2	1.3	1.5	2.1	2.2	2.4
32A	2.3	2.8	3.5	3.8	4.5	5.2
40A	2.2	2.7	3.3	3.8	4.4	5.0
50A	4.5	5.2	6.3	8.0	9.2	10.2
65A	9.8	11.8	14.3	17.6	20.2	22.6
80A	9.0	11.0	13.5	16.6	19.2	21.8
100A	14.5	17.6	20.5	26.5	29.5	32.3

■ Masses of AS Series (kg)

Size	Style					
	1	2	3	4	5	6
10A	0.6	0.7	0.9	1.3	1.4	1.6
15A	0.55	0.65	0.85	1.3	1.4	1.6
20A	1.3	1.55	1.9	3.1	3.1	3.4
25A	1.2	1.5	1.75	3.0	3.0	3.3
32A	2.0	2.8	3.8	4.2	4.9	5.6
40A	2.1	2.8	3.6	4.7	5.2	5.8
50A	4.0	5.5	7.3	-	-	-
65A	5.5	6.2	6.9	-	-	-
80A	7.0	7.6	8.6	-	-	-

■ Masses of B Series (kg)

Size	Style		
	1	2	3
10A	0.8	1.0	1.2
15A	0.7	0.9	1.1
20A	1.9	2.2	2.8
25A	1.8	2.1	2.7
32A	2.2	2.8	3.4
40A	2.3	3.4	4.4

■ Masses of C Series (Standard Specification) (kg)

Size	Style					
	1	2	3	4	5	6
40A	5.3	5.5	5.7	7.2	7.4	7.6
50A	7.2	7.6	8.0	10.6	11.0	11.3
65A	10.4	11.0	11.5	15.3	15.8	16.4
80A	11.3	12.1	13.0	17.0	17.9	18.7
100A	15.6	17.0	18.5	24.6	26.0	27.4
125A	25	27	29	39.5	42	44
150A	39	42.5	46	65	68.5	72
200A	59	67	74	104	112	119
250A	87	101	114	152	168	182
300A	120	140	160	220	240	260

■ Masses of CS Series (Standard Specification) (kg)

Size	Style					
	1	2	3	4	5	6
40A	5.3	5.4	5.6	7.2	7.4	7.6
50A	7.2	7.5	7.9	10.6	11.0	11.3
65A	10.4	10.9	9.0	15.3	15.8	16.4
80A	11.3	12.0	12.9	17.0	17.9	18.7
100A	15.6	16.9	18.5	24.6	26.0	27.4
125A	25	27.4	30	39.5	42	44
150A	39	42.5	46	65	68.5	72
200A	59	68	76.5	104	112	119

Note) Standard specification flanges of the C and CS series are JIS10K.

Dynamic Torque

A/AS Series Dynamic torque(10A~100A)

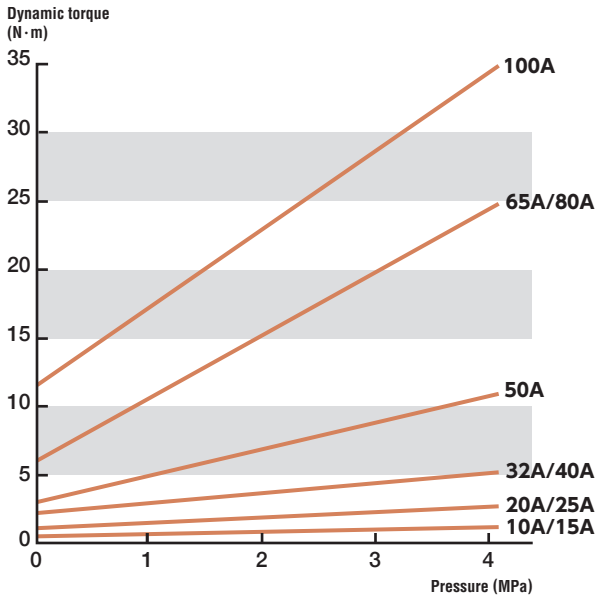

B Series Dynamic torque(10A~40A)

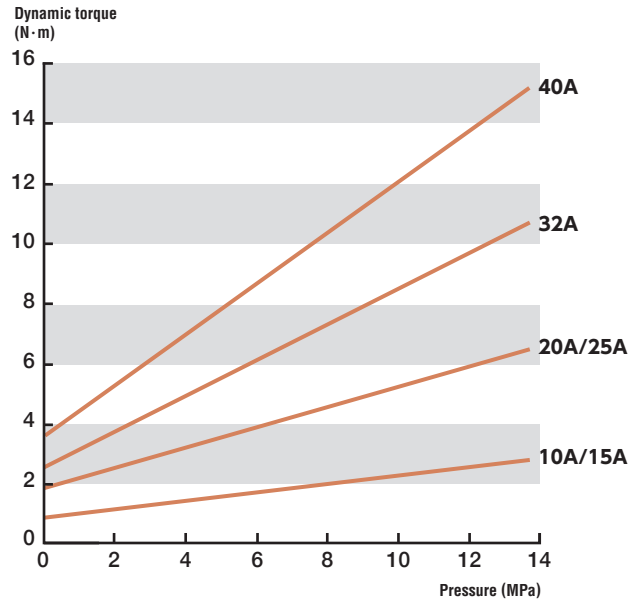

C/CS Series Dynamic torque(40A~80A)

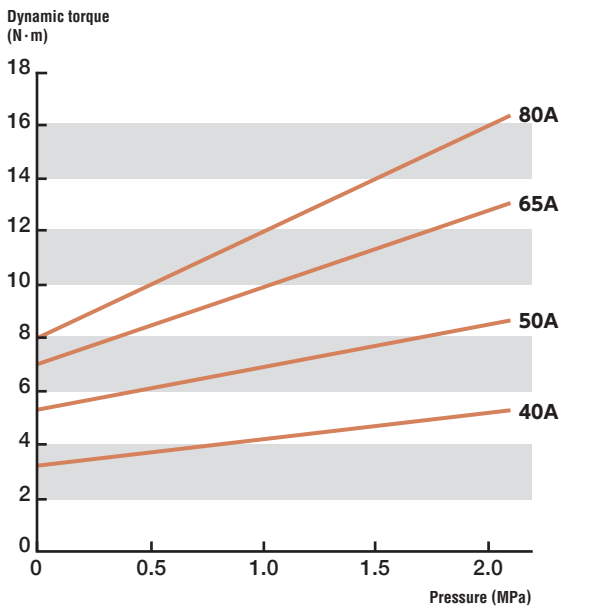

C/CS Series Dynamic torque(100A~300A)

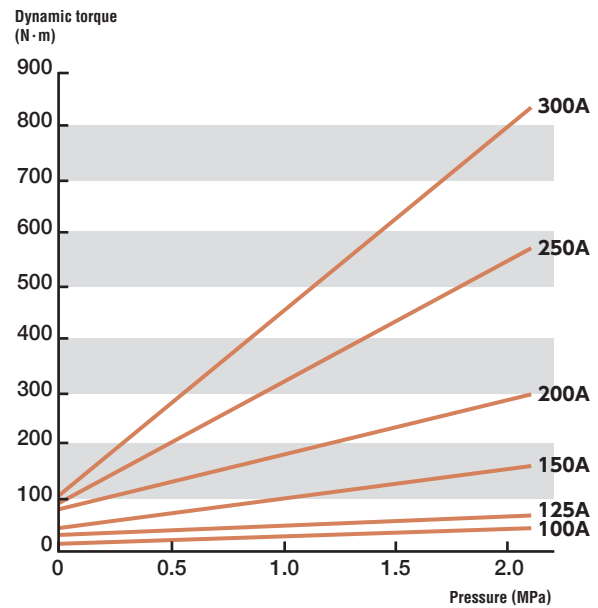

Note 1) Dynamic torque varies depending on product storage conditions, storage period, or fluid types.

2) Starting torque is larger than dynamic torque. Although starting torque is even larger when wringing occurs, it does not indicate any fault.

3) Data are typical values measured based on in-house test standards. They are not guaranteed values.

Model Names and Types

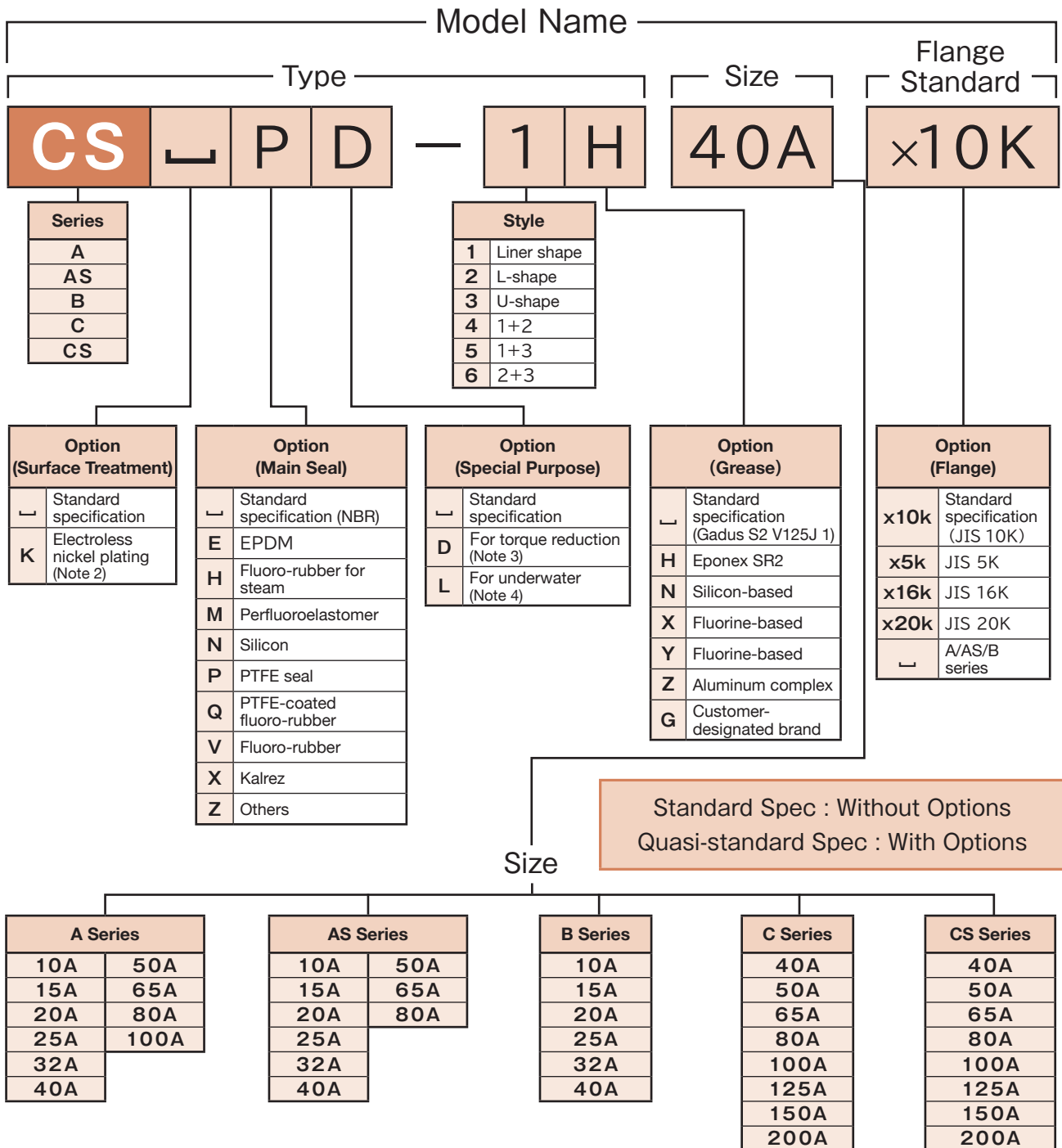

Note 1) "┌" indicates a space. A model name is indicated without spaces.

2) Electroless nickel plating is applied to the shaft and body when option (surface treatment) code K is selected. This is applicable to the A series (65A - 100A) and C series (all sizes).

3) The dust seal is replaced with felt when option (special purpose) code D is selected.

4) The grease nipple is replaced by a plug with liquid packing applied to the thread when option (special purpose) code L is selected.

5) Flanges of the C and CS series are JIS10K SOP FF as standard.

6) If modifications not included in the options are made, a type indication starts with AO, ASO, BO, CO, or CSO to denote a customized product.

If you have any questions, contact our sales representative.

Precautions on Selection

1. Select a product whose operating conditions are within the service conditions (listed in the table on page 2).
2. The bearing section is high precision machined and there is no clearance (play). Shaft movement is restricted in the swivel direction. When introducing a hose for connecting the product or a movable pipeline for using multiple products, carefully consider the motion of the hose and the movable pipeline before selecting a style.
3. Select an option as necessary.
 - 1) See “Model Names and Types” (page 9) for the types of options.
 - 2) Depending on the fluid used or application, you can change the standard specification main seal (NBR) and grease (Gadus S2 V125J 1) to your desired materials. (See the table below.)
 - 3) The standard specification main seal (NBR) cannot be used for phosphoric ester-based hydraulic oil, chlorinated hydrocarbon-based hydraulic oil, organic solvents, or acids.
 - 4) A PTFE seal is a spring-loaded seal consisting of a Teflon cover and a metal spring. Teflon is easily deformed in a plastic manner. Therefore, using a Teflon seal in a vacuum condition or applying a high moment load to it may deform the seal, possibly resulting in fluid leakage.
4. The use of the product in a continuous rotation condition is not appropriate.
5. Oil released from grease in the bearing section may seep from the gap between the ball plug and body.
6. The product cannot be used for fluid that causes corrosion on it.
7. The product is not designed according to the general design rules for safety and hygiene of food processing machinery (JIS B 9650). Consult with us when considering the use of the product in food-related facilities.
8. Depending on the fluid used, the product may subject to restrictions due to national laws or local regulations.

As for customized products, we can produce products with modifications that are not included in the options.

If you have any questions or wish to purchase customized products, contact our sales representative.

(*) We can produce products for which the ANSI150 lb, ANSI300 lb or JPI flange, or socket welding or butt welding is used for connection.

■ Main Seal Material and Service Temperature Range (Guideline)

Option Code (Main Seal)	Material	Temperature Range (°C)
└	NBR(Standard)	-20~100
E	EPDM	-40~120
H	Fluoro-rubber for steam	~160
M	Perfluoroelastomer	~200
N	Silicon rubber	-50~150
P	PTFE seal	~180
Q	PTFE-coated fluoro-rubber	~160
V	Fluoro-rubber	-10~160
X	Kalrez	~250
Z	Others	-

■ Grease Type and Service Temperature Range (Guideline)

Option Code (Grease)	Brand	Material	Application	Temperature Range (°C)
└	Gadus S2 V125J 1 (Standard)	Lithium-based	General purpose	-35~120
H	Eponex SR2	Lithium complex	General purpose	-20~200
N	-	Silicon-based	General purpose	-40~200
X	-	Fluorine-based	High-temperature	-30~260
Y	-	Fluorine-based	Oxygen	-15~150
Z	-	Aluminum complex	Food-processing machinery	-20~160
G	Customer's designation	-	-	-

Kalrez® is a registered trademark of E.I. du Pont de Nemours and Company.

Gadus S2 V125J 1 is a product of Shell Lubricants Japan K.K.

Eponex SR2 is a product of Idemitsu Kosan Co., Ltd.

Note 1) “Temperature range” in the table shown on the left indicates service temperature ranges of the main seals.

2) “Temperature range” in the table shown on the right indicates service temperature ranges of the greases.

Maintenance

1) Greasing

The bearing section and main seal require periodic greasing (refilling).
Perform greasing with reference to the frequency (guideline) shown to the right.

- ★ Use the following brand of grease filled in the product before shipment.
- ★ Gadus S2 V125J 1 (Shell Lubricants Japan K.K.) is filled as a standard specification.
- ★ Grease different from the standard specification is filled if a model name includes an option (grease) code.

Greasing Frequency (Guideline)

Fluid Temperature (°C)	Greasing Frequency
0~60	Yearly
60~100	Every six months

2) Replacement of consumables

You can use the product for an extended period of time by replacing consumables.

Contact us for replacement. We carry it out according to our repair program.

Depending on the products, expenses for purchasing new products may be lower than repair expenses.

Contact us for more information.

Product Order

Please provide the following information.

1) When ordering our product you are currently using

- ① Model name (indicated on the product's nameplate)
- ② Flange size (for only C/CS series)

2) When newly ordering our products

- ① Model name (see page 9.)
- ② Flange size, flange standard (for C/CS series only)
- ③ Related information
 - The name of equipment to which our product is installed
 - The name of the fluid used
 - Fluid pressure and temperature
 - Operation (rotation or swivel) and its frequency
 - Service environment
 - Requests, etc.

If you have any questions, contact our sales representative.

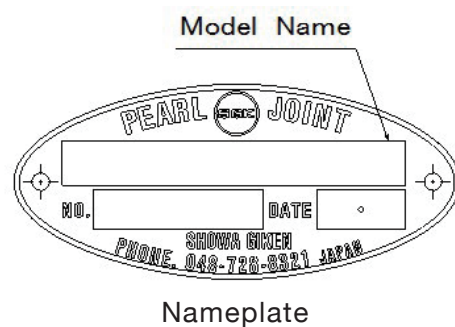

Product Warranty

If a malfunction occurs during the warranty period, contact us or the distributor and send the product to us. Be sure to carefully pack the product for protection before sending it. After receiving the product, we will confirm the malfunction. If the malfunction was clearly caused by the materials of product components or the manufacturing method, we will repair the product in question or replace it with a new one free of charge.

Product Warranty Provision

1. Warranty Period

< New products >

One (1) year and six (6) months after shipment (from the manufacturing date) or one (1) year after installation, whichever comes first.

< Repaired products >

Six (6) months after shipment (from the manufacturing date).

2. We charge a fee for repairs in any of the following cases.

- ① Failure after the warranty period has expired
- ② Failure caused by use of the product deviating from the service conditions
- ③ Failure caused by misuse (improper storage, installation, pipe laying, operation or maintenance, etc.)
- ④ Failure caused by fluid contaminants or foreign objects in the fluid
- ⑤ Failure caused by relocation, transport, or falling of the product after delivery
- ⑥ Failure caused by disassembly, repair, or modification done by personnel other than our service personnel
- ⑦ Failure of the product attributed to using materials or according to standards specified by the customer
- ⑧ Failure of the product attributed to using materials provided by the customer
- ⑨ Failure caused due to unavoidable acts of nature such as fires or other natural disasters

3. Scope of Responsibility

Our responsibility shall be limited to repairs, replacements, or transport expenses covered by this product warranty provision. Expenses or damages caused by said failures above shall not be covered.

4. Applicable Regions

This product warranty provision shall be applicable to products installed in Japan.
Contact our sales representative if you install and use our products outside Japan.

5. Another Agreement

If another product warranty agreement is made separately with us and clearly states that said agreement shall have priority over this product warranty provision, this provision shall not be applicable.

6. This product warranty provision shall not restrict the customer's legal rights.

PEARL  JOINT
株式会社 昭和技研工業
SHOWA GIKEN INDUSTRIAL CO., LTD.

URL <https://www.sgk-p.co.jp>



Export Department Phone : +81-3-3598-1400 Fax. : +81-3-3598-2700
E-mail : sgk-tk@sgk-p.co.jp

Headquarters 7-24, Nishi-Kobari, Ina-Machi, Saitama, 362-0811 Japan
Phone : +81-48-728-9460 Fax. : +81-48-728-9461

Tokyo Sales Office 2-64-11, Akabane, Kita-ku, Tokyo, 115-0045 Japan
Phone : +81-3-3598-1400 Fax. : +81-3-3598-2700

Osaka Sales Office 2-9-7, Toyosaki, Kita-ku, Osaka, 531-0072 Japan
Phone : +81-6-6371-8341 Fax. +81-6-6371-6283

Nagoya Sales Office 41-1, Higashi-Ozone-cho, Higashi-ku, Nagoya, 461-0022 Japan
Phone : +81-52-938-8825 Fax. : +81-52-938-6423